

Hakca® FORM-C SYSTEMS

- ADJUSTABLE COLUMN FORMWORK SYSTEMS
- СТАЛЬНЫЕ ОПАЛУБОЧНЫЕ СИСТЕМЫ ОПАЛУБКА КОЛОНН
- أنظمة القوالب الفولاذية

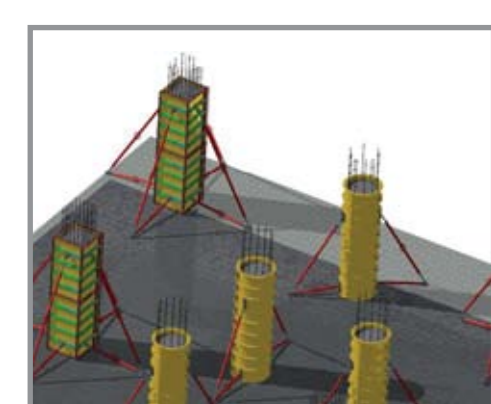

- Can be applied to circular or adjustable square concrete forms. Both plywood and steel surface types are available for fresh concrete pressure.

DURABLE FOR LENGTHY PERIODS

2

Hakca® FORM-M SYSTEMS

- MODULAR FORMWORK SYSTEMS
- СТАЛЬНЫЕ ОПАЛУБОЧНЫЕ СИСТЕМЫ МОДУЛЬНАЯ ПАНЕЛЬНАЯ ОПАЛУБКА
- أنظمة القوالب الفولاذية

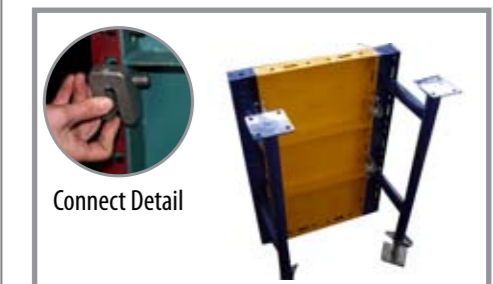

- Panel forms with various dimensions can be used, in conjunction with soldier, steel waler, push-pull prop, tie rod, platform console and other accessories.

Hakca® FORM-W SYSTEMS

- WALL FORMWORK SYSTEMS
- СТЕНОВАЯ ЩИТОВАЯ ОПАЛУБКА
- أنظمة القوالب الفولاذية

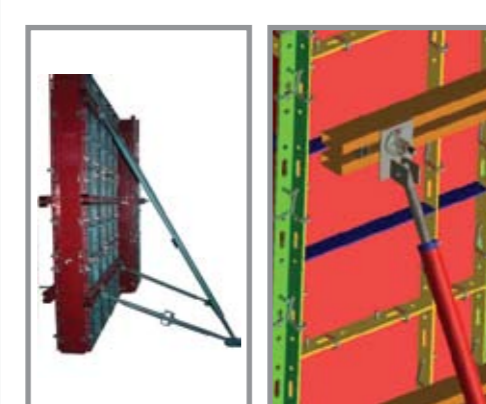
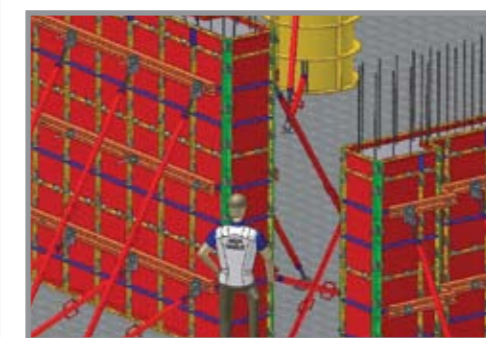
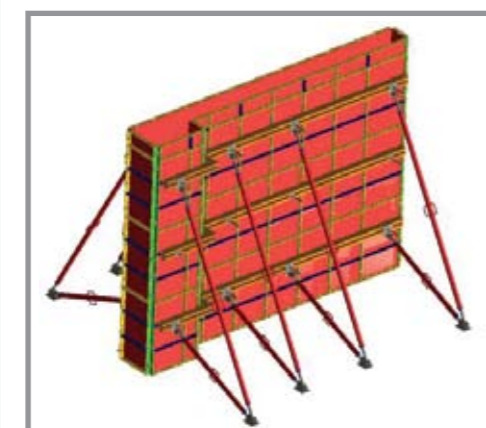

- Used as plywood wall forms or steel surfaces in industrial plants, housing construction, infrastructure projects and so forth.

SAFE USE

Hakca® FORM-H20W SYSTEMS

- H20 WOODEN GIRDER WALL FORMWORK SYSTEMS
- H20 ДЕРЕВЯННОЕ ФЕРМА СТЕНКИ ОПАЛУБОЧНЫЕ СИСТЕМЫ
- عارضه أنظمة الحائط الخشبي ال H20

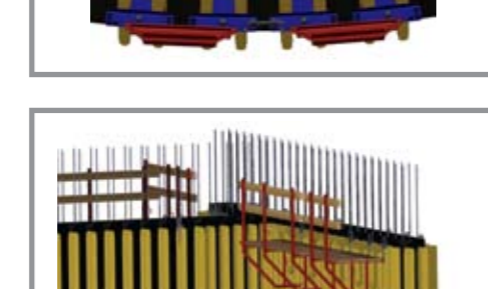
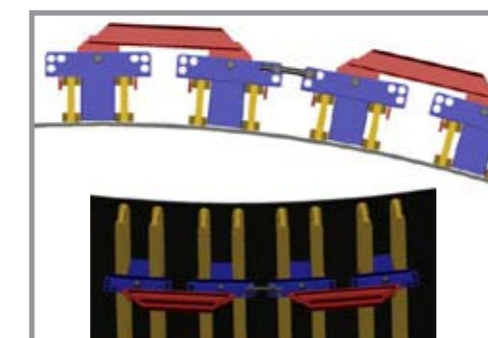
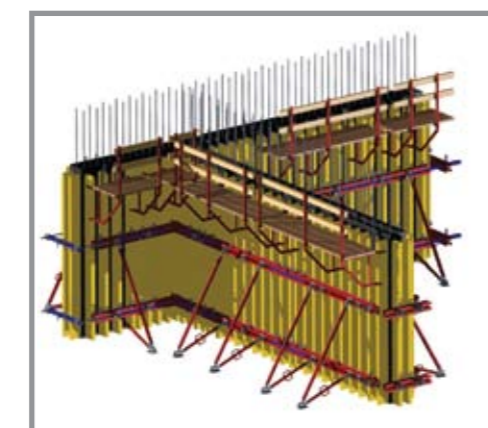

- Wall Formwork Systems is a widespread formwork system with components such as H20 Wooden Girder, plywood, steel waler, push-pull prop, platform console and other accessories.

DESIGN FOR SPECIFIC PROJECTS

3

Hakca® FORM-H20C SYSTEMS

- H20 WOODEN GIRDER FORMWORK SYSTEMS
- H20 ДЕРЕВЯННОЕ ФЕРМА ОПАЛУБОЧНЫЕ СИСТЕМЫ
- H20 عارضه أنظمة الخشبي

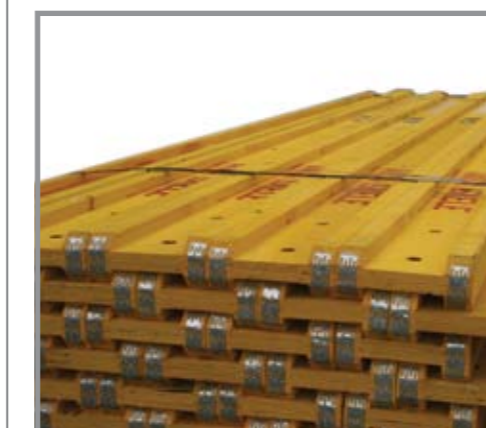

- H20 Wooden Girder forms with various dimensions can be used, in conjunction with plywood, steel waler, push-pull prop, platform console and other accessories.

Hakca® FORM-H20C SYSTEMS

- H20 WOODEN GIRDER COLUMN FORMWORK SYSTEMS
- H20 ДЕРЕВЯННОЕ ФЕРМА COLUMN ОПАЛУБОЧНЫЕ СИСТЕМЫ
- H20 عارضه أنظمة العمود الخشبي

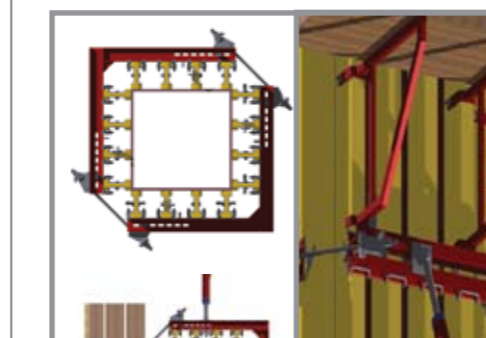
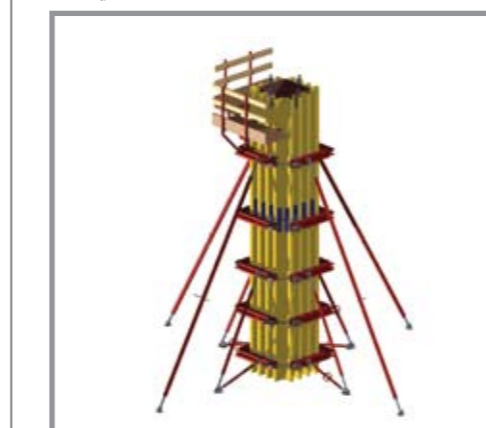

- Column Formwork Systems is a formwork system that can be moved around via a crane. This system can be produced according to design requirements.

PRACTICAL ASSEMBLY

4

Hakca® FORM-P SYSTEMS

- FORMWORK OF PRE-CAST ELEMENTS
- СТАЛЬНЫЕ ОПАЛУБОЧНЫЕ СИСТЕМЫ СБОРНАЯ ОПАЛУБКА
- أنظمة القوالب الفولاذية



- Pre-cast formwork systems offer ideal solutions for fast projects in a short time.

MANUFACTURE ON DEMAND OF PRE-CAST SYSTEMS

4

Hakca® FORM-S SYSTEMS

- PANELS FOR SLAB (STEEL SURFACED)
- STANDARTНЫЕ ЩИТЫ ПЕРЕКРЫТИЙ
- أنظمة القوالب الفولاذية

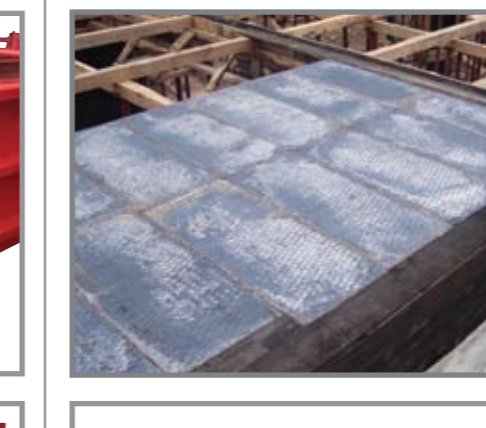

- Steel surfaced standard panels are designed with one or two security stripes. Panel steel is manufactured double-twisted all over.

MULTIPLE SUCCESSFUL USE

5

Hakca® FORM-S SYSTEMS

- CLIMBING FORMWORK SYSTEMS
- ПОДЪЕМНО-ПЕРЕСТАВНАЯ ОПАЛУБКА
- أنظمة القوالب الفولاذية

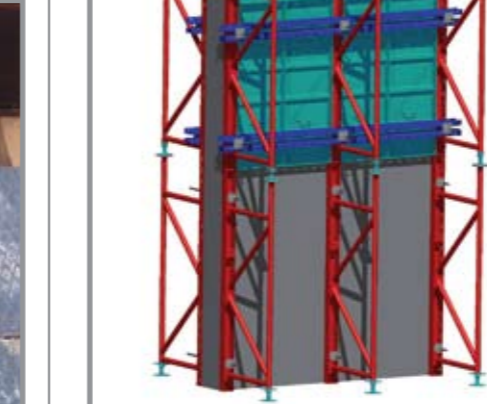
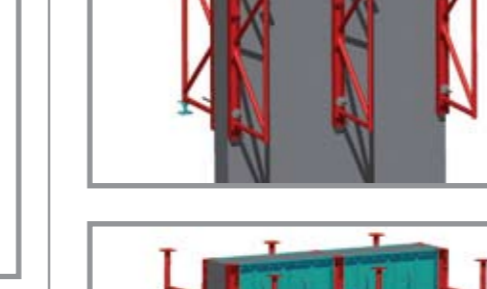
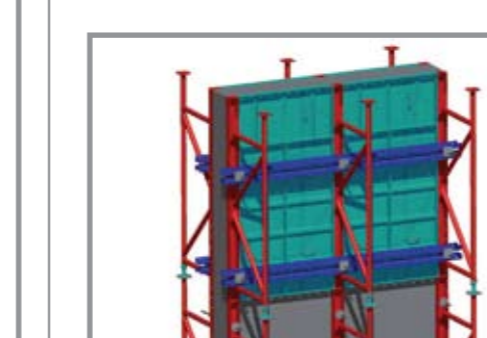
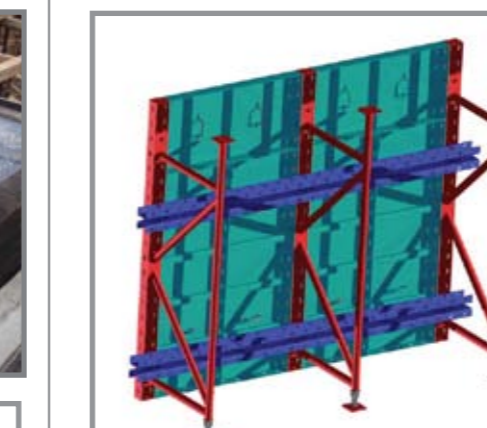

- Climbing Formwork Systems is a system, assembled manually or via crane, that carries the wall formworks on the outside of the building.

REPEAT USE MANY A TIME

5

Hakca® PROP-S SYSTEMS

- ADJUSTABLE PROP SYSTEM
- СИСТЕМЫ РЕГУЛИРУЕМЫХ ПО ВЫСОТЕ ТЕЛЕСКОПИЧЕСКИХ СТОЕК
- إسناد التلسكوب

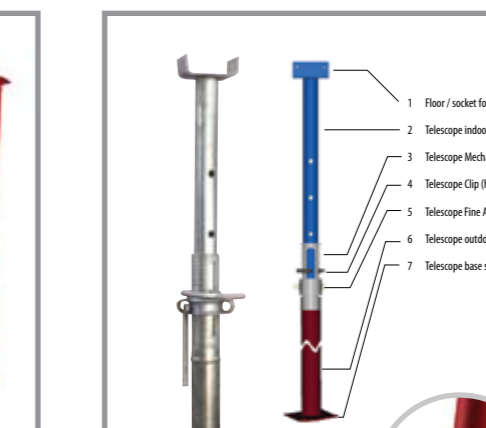

- An adjustable construction component with its high capacity to carry heavy loads is used with slab and beam. Easy to assemble and disassemble.

SOME EXAMPLES FROM OTHER ACCESSORIES

5

Hakca® SF-ACC. SYSTEMS

- ACCESSORIES OF SCAFFOLDING FORMWORK SYSTEMS

- ADJUSTABLE COLUMN CLAMP
- ВСПОМОГАТЕЛЬНЫЕ И КОМПЛЕКТУЮЩИЕ ИЗДЕЛИЯ
- أساور الأعمدة القابلة للتعديل



- Clamps in sizes ranging from 60 cm to 150 cm are manufactured for rectangle and square shapes. It is suggested that they are used in appropriate positions and numbers on a pair with the weight.

- ADJUSTABLE PUSH-PULL PROP
- ТЕЛЕСКОПИЧЕСКИЙ ПОДКОС (ПОДПОРКА)



- Used as supplementary elements, they are manufactured in right- and left-screw as well as telescopic types.

- SPRING FORM LOCK
- ПРУЖИННАЯ ЗАЖИМНАЯ ПЛАСТИНА ДЛЯ ОПАЛУБОК
- الأيلاكاج



- An auxiliary construction member, it is used to keep the column and wall measurements in original specifications during fresh concrete casting.

- ВСПОМОГАТЕЛЬНЫЕ И КОМПЛЕКТУЮЩИЕ ИЗДЕЛИЯ
- الإكسسوارات والعناصر الإضافية

- TIE ROD AND ACCESSORIES
- СТЯЖКА ВИНТОВАЯ И КОМПЛЕКТУЮЩИЕ
- البولون الحديدي



- Tie rod is an auxiliary component used to keep the concrete forms in equal distance, with a diameter of $\varnothing 17$ or $\varnothing 24$ mm. made from steel.

- INFRASTRUCTURE COMPONENTS FOR TELECOMMUNICATION
- КОМПЛЕКТУЮЩИЕ ДЛЯ ТЕЛЕКОМУНИКАЦИОННЫХ И ИНФРАСТРУКТУРНЫХ УСТРОЙСТВ



- Infrastructure components and equipment are manufactured in line with specifications of your projects.

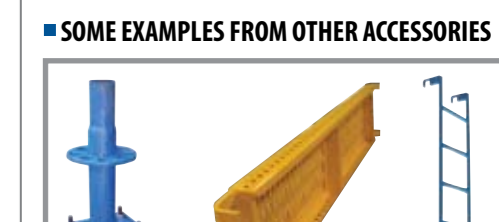

- SOME EXAMPLES FROM OTHER ACCESSORIES

5

Hakca® | MSAF-F SYSTEMS
MOBILE SCAFFOLDS AND EQUIPMENT
 СТРОИТЕЛЬНЫЕ ЛЕСА ПЕРЕДВИЖНЫЕ
 ВЫШКИ - ТУРЫ
 السقالة المتنقلة والمعدات

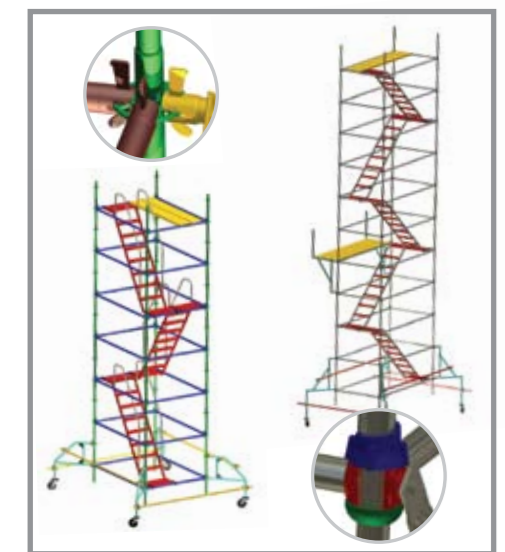

IT IS EXTREMELY EASY TO ASSEMBLE AND DISASSEMBLE

Hakca® | SCAF-C SYSTEMS
CUPLOCK SCAFFOLDING SYSTEMS
 СИСТЕМЫ СТРОИТЕЛЬНЫХ ЛЕСОВ С ЧАШЕЧНЫМ КРЕПЛЕНИЕМ (CUPLOCK)
 السقالة والمعدات

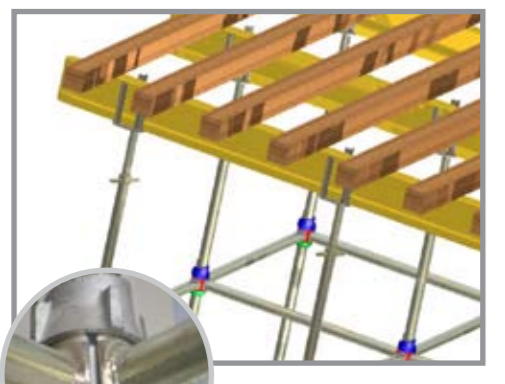

Preferred for its durability and safe use and handling, and heavy load carrying capacity.

Hakca® | USCAF-H SYSTEMS
HEAVY TYPE "H" LOAD-BEARING SCAFFOLDING AND EQUIPMENT
 СТРОИТЕЛЬНЫЕ ЛЕСА ПОД ОПАЛУБКУ ПЕРЕКРЫТИЯ
 السقالة والمعدات

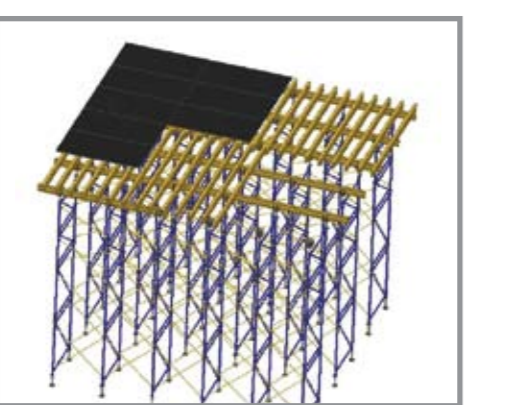
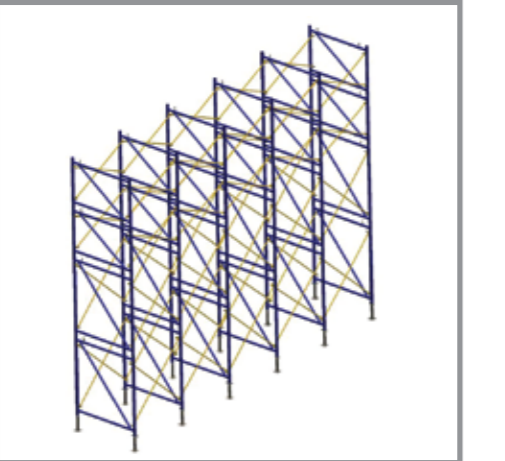
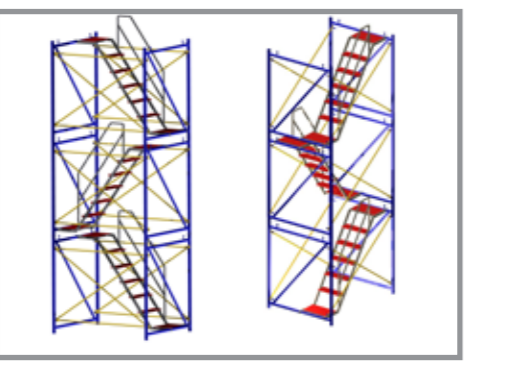
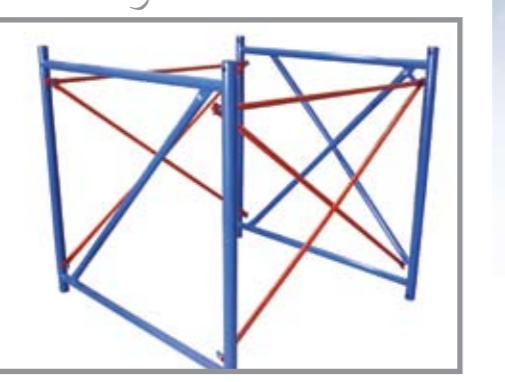

H150 Scaffolding Systems are preferred for its capacity to carry heavy loads, with few and standard components needed. These systems can be used either in floor table or shoring tower or even stair tower forms.

Who are we? (ABOUT US)
 AKÇA CONSTRUCTION, SCAFFOLDING and FORMWORK INDUSTRY TRADE Ltd Co has been one of the leading manufacturers of scaffolding and formwork systems and appliances with an immense experience and expertise since 1974.

Who service do we provide?
 We are timely and prompt in the delivery of service, designed to meet customer demands and expectations on competitive terms. Supported by an experienced team of engineers, designers, human resources personnel, skilled workforce, the company delivers first class service to all countries all over the worlds. Among these services are on-site assessment and project design, scaffolding and formwork rentals.

What do we produce?
 Our production systems are of world standards: the fully automatic machinery and integrated production systems allow us to manufacture all the products on site. AKÇA product range is wide: it includes, but by no means restricted to, scaffolding systems, platforms, beams, posts, concrete covers, adjustable form works, and pre-cast elements, modular handset forms as well as large panel forms, heavy-duty ganged forms (with either steel or plywood surface), custom-tailored form precast forms and so forth. The company keeps updating product quality and range in line with technological developments.

What is our experience in sales and service?
 The countries we ship our products to and provide service includes Ukraine, Kazakhstan, Turkmenistan, Romania, Georgia, Cyprus, Azerbaijan, Afghanistan, Saudi Arabia, Qatar, Syria, Iraq, Libya in Africa, Asia, and the Middle East.

SOLUTION CENTRE FOR PROFESSIONAL CONTRACTORS AND DEVELOPERS

как Азербайджан, Туркменистан, Кипр, Ирак, Ливия, Афганистан, С. Аравия, Катар, Грузия и т.д.

Принцип нашей работы:

«Качество» и «Полное удовлетворение запросов клиентов»

Мы готовы ответить всем вашим потребностям, начиная от систем строительных лесов до стальных опалубочных систем, от телекоммуникационного оборудования до деталей инфраструктуры

И ОКАЗАТЬ ПОДДЕРЖКУ В ОСУЩЕСТВЛЕНИИ ВАШИХ ПРОЕКТОВ.

Компания AKÇA İnşaat İskele ve Kalıp Sanayi Tic. Ltd
 благодаря своему обширному опыту и навыкам производства со дня своего учреждения вносит свой неоспоримый вклад в область строительства, которая играет роль локомотива в развитии стран и государств.

Наше предприятие структура, которой позволяет полную интеграцию, осуществляет и производство многих вспомогательных и комплектующих деталей для собственной продукции, обновляется и развивается параллельно технологическим разработкам.

Любое наше изделие, которое изготавливается на производственных объектах, где работают инженеры, технические учителя и опытные рабочие, проходит через тщательные фильтры контроля качества. Изделия, наряду с реализацией в Турции, предлагаются клиентам в таких странах,

من نحن؟ (معلومات عنا)
 شركة AKÇA للمقاولات والسقالة والهياكل الصناعية التجارية ذ. م. م.
 من الشراكات الرائدة في إنتاج السقالة وأنظمة الهياكل بتجربة وخبرة كبيرة منذ 1974

ماذا ننتج؟
 إن منتجاتنا بمستوى الموصفات العالمية: إن المكانن الآلية الكاملة وأنظمة الإنتاج المُندمج يمنحنا القدرة على إنتاج جميع المنتجات في الموقع.
 إن مجال منتجاتنا AKÇA واسع النطاق: تحتوي على وبدون تحديد، أنظمة السقالة، المنصات، الأحزمة، المفصلات، الأغطية الأسمتية، أعمال قابلة للتشكيل، العناصر التي تم تحضيرها مُسبقاً، الأعمال الثقيلة (بوجه فولادي أو أبلاكاج)، التصميم المُسبق حسب طلبات الزبائن. تعمل الشركة على تحديث جودة مجال المنتجات باستخدام التقنيات الحديثة.

ماهي تجربتنا في البيع والخدمات؟
 نقوم بإرسال منتجاتنا وخدماتنا إلى تركمنستان، أوكرانيا، رومانيا، جورجيا، قبرص، أذربيجان، أفغانستان، المملكة العربية السعودية، قطر، سوريا، العراق، ليبيا في الشرق الأوسط وأفريقيا وآسيا.

ماهي الخدمات التي نوفرها؟
 نقوم بتوفير الخدمات بسرعة وفي مواعدها، والتصاميم التي توافق طلبات وتوقعات الزبائن بشكل مناسف. بدعمنا بذلك الفريق ذو الخبرة والمهندسين والمصممين والموارد البشرية والقوة العاملة. نقوم الشركة بتقديم الخدمات من الدرجة الأولى لجميع الدول في جميع أنحاء العالم. ومن هذه الخدمات التقييم في مكان العمل، تصميم المشاريع وتاجير السقالة والهياكل.

الرجاء إعلاننا بطرق أخرى نستطيع تقديم الخدمات لكم
 الشكر الجزيل على اهتمامكم الطيب

تصاريح اعتماد
 TÜV CERT
 KOSGEB

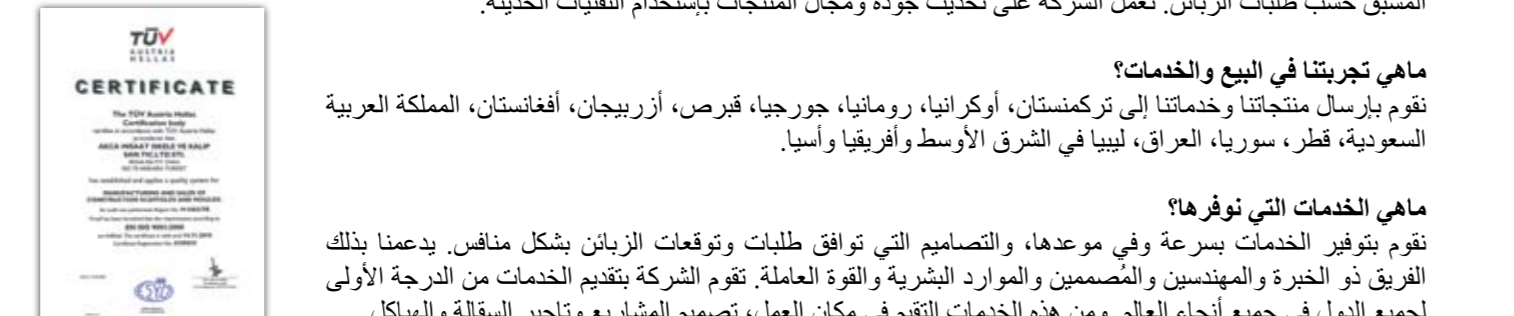
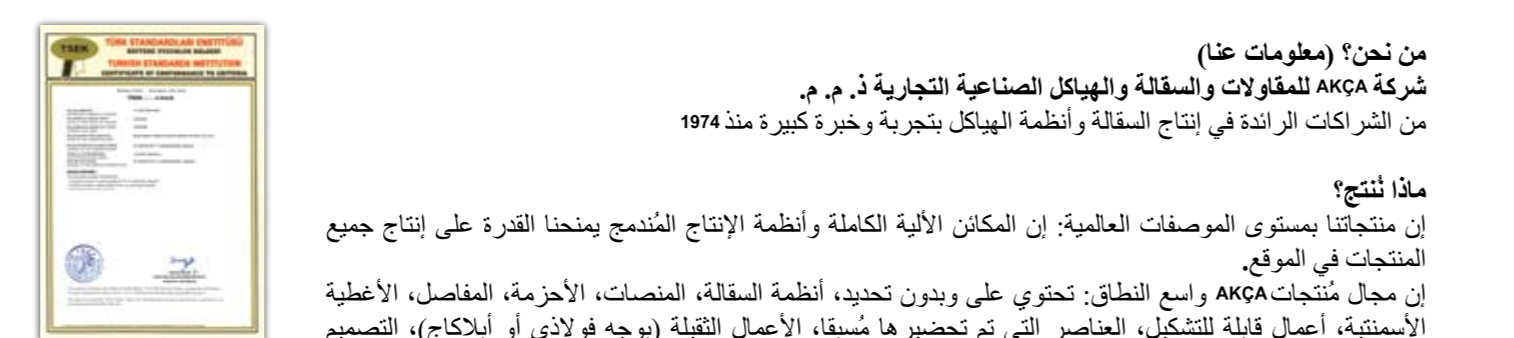

AKÇA CONSTRUCTION SCAFFOLDING AND FORMWORK INDUSTRY TRADE LTD. CO.
AKÇA İNŞAAT İSKELE ve KALIP SAN. TİC. LTD. ŞTİ.
 Head Office : 40. Sokak No: 111 Ostim 06370 ANKARA / TURKEY
 Factory : Sarayköy / Kazan / ANKARA / TURKEY
 Phone : +90 312 354 42 25 (Pbx) Fax: +90 312 385 47 49
 www.akcaiskele.com - www.scaffoldingturkey.com
 www.scaffoldsystem.net - www.formworksystem.net

35 years of experience
 right decision

DEPENDABLE COLLABORATION
 info@akcaiskele.com
 sales@akcaiskele.com



İskele AKÇA
 SCAFFOLDING & FORMWORK SYSTEMS
 www.akcaiskele.com

Hakca®
 SCAFFOLDING & FORMWORK SYSTEMS

DEPENDABLE COLLABORATION

Hakca® | SCAF-F SYSTEMS
WEDGE CONNECTION AND FLANGE SYSTEM
 СИСТЕМЫ СТРОИТЕЛЬНЫХ ЛЕСОВ С КЛИНОВЫМ - ФЛАНЦЕВЫМ КРЕПЛЕНИЕМ
 أنظمة السقالة



Connection flange scaffolds systems are easily assembled and disassembled, and can be erected for desired width and length.

Hakca® | SCAF-H SYSTEMS
"H" TYPE FACADE SCAFFOLDING SYSTEMS
 СТРОИТЕЛЬНЫЕ ЛЕСА РАМНОГО ТИПА
 أنظمة السقالة

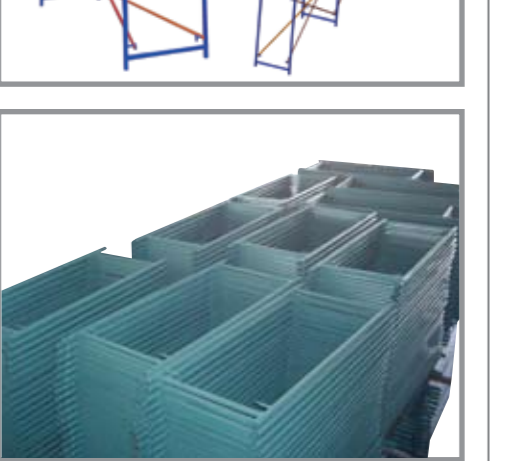
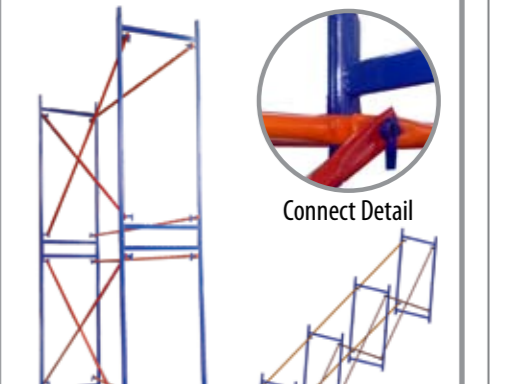
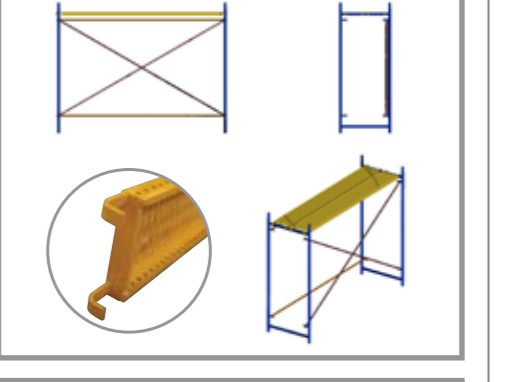

"H" type service scaffolding: Preferred for its easy assembly or disassembly.

Hakca® | MSAF-E SYSTEMS
"E" TYPE MOBILE SCAFFOLDING SYSTEMS
 СТРОИТЕЛЬНЫЕ ЛЕСА ПЕРЕДВИЖНЫЕ
 ВЫШКИ - ТУРЫ
 السقالة المتنقلة والمعدات



A scaffolding system used in multi-purpose work places. Tailor-produced for specific projects such as airport construction sites, industrial plants, and so forth.

IT PRESENTS FLEXIBILITY, ASSEMBLY PRACTICALITY AND SPEED TOGETHER.